

APPLIANCE RELAYS

AMERICAN ZETTLER, INC.

It's a better relay!

Appliance Relays

AZ9405

- Contact rating of 10A; SPST, SPDT
- Class F insulation available
- 3-48VDC coils with sensitive version to 24V
- UL approvals for 100K cycles at 85°C
- 4kV dielectric



Competitor parts

- TE - PCH / T77
- Omron - G5Q/G5SB
- Song Chuan - 892/892H
- Panasonic - JQ/PQ

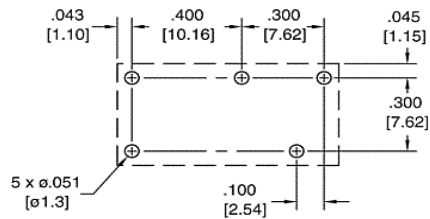

AZ7709

- Contact ratings of 3, 5, 8, 10A; SPST-NO
- Class F insulation available
- 3-48VDC coils with sensitive version to 24V
- UL approvals for 100K cycles at 85°C
- 4kV dielectric; 10kV surge



Competitor parts

- TE - T77/OJE
- Fujitsu - JV
- Song Chuan - 835

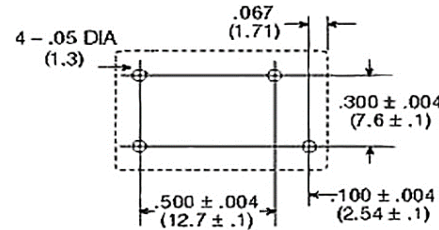

AZ9375

- SPST with a contact rating of 10A
- Class F insulated wire standard
- 3-24VDC coils
- UL approvals for 100K cycles at 90°C
- 4kV dielectric



Competitor parts

- TE - PCJ
- Omron - G5NB/G5T
- Song Chuan - 202/202HT
- Panasonic - LD
- Fujitsu - FTR-F3

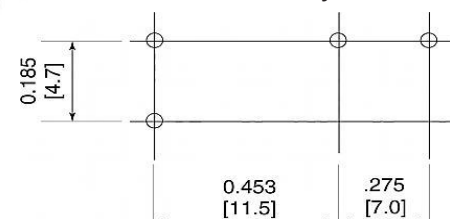

AZ943

- Contact rating of 15A; SPST, SPDT
- Class F insulation available
- 5-48VDC coils
- UL approvals for 100K cycles
- 6kV dielectric version available



Competitor parts

- TE - T7C/ORWH/PCE
- Panasonic - JS/JSM
- Omron - G5LA/G5LE
- Song Chuan - 899/307

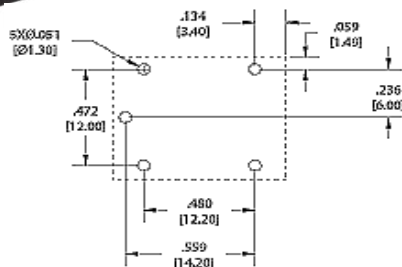

AZ921

- Contact rating of 5A; SPST-NO
- Single inline package
- 5-24VDC coils, Class F insulation available
- UL approvals for 100K cycles
- Bifurcated contact option
- Multiple footprints



Competitor parts

- TE - PCN
- Panasonic - PA
- Fujitsu - NY

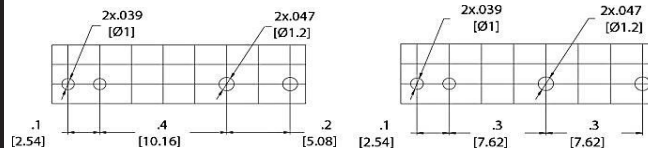

AZ576 / AZ742 / AZ743

- SPST, SPDT 20A; DPST, DPDT - 10A
- 5-110VDC, 24-230VAC coils
- UL approvals for 100K cycles, 105°C
- Class F insulation available
- 5kV dielectric; 10mm isolation spacing



Competitor parts

- TE - RTD/RTE
- Omron - G2RL/G5RL
- Song Chuan - 507/888H

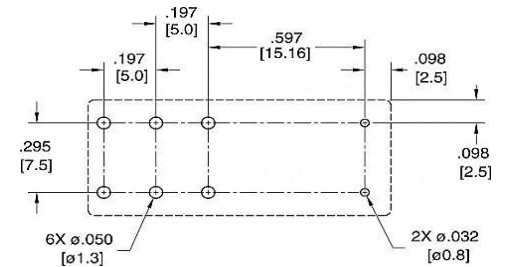

AMERICAN ZETTLER, INC.

It's a better relay!

Appliance Relays

AZ2150 / AZ21501 - Heavy Duty PCB

- Contact ratings up to 40A; SPST, SPDT
- Class F insulation available
- 5-120VDC, 12-240VAC coils
- Meets UL508 and UL873
- 4kV dielectric available

Competitor parts

- TE - T90/T9A
- Omron - G8PT
- Song Chuan - 832A
- Sanyou - SLA

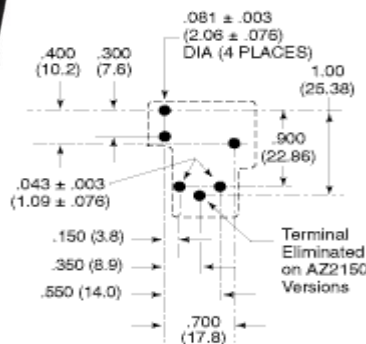

AZ7695 - High Inrush, QCT Option

- Contact rating of 25A (80A inrush); SPST
- Class F insulation available; 5-48VDC coils
- PCB or PCB w/QCT
- 5kV dielectric; 10kV surge

Competitor parts

- TE - PCF
- Omron - G4A
- Song Chuan - 821

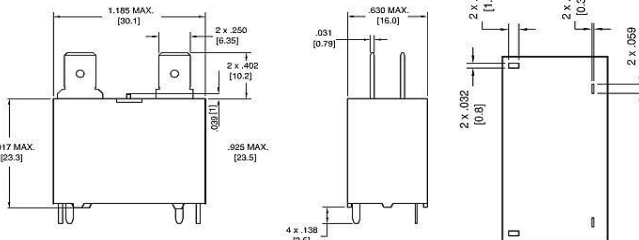

AZ7555 - High Capacity All-Purpose

- Contact rating of 20A; SPST, SPDT
- Class F insulation available
- 3-48VDC coils with sensitive version (120mW)
- UL approvals for 100K cycles at 85°C
- 5kV dielectric; 10kV surge

Competitor parts

- TE - OZ, OMIH
- Omron - G2R
- Panasonic - JW/JR1AF
- Song Chuan - 793

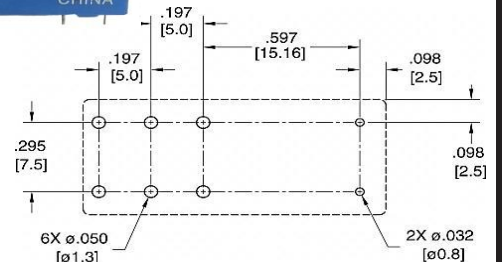

AZ2100 - Power PCB w/QCT

- Contact rating of 40A; SPST, SPDT
- Class F insulation available
- 5-120VDC, 12-240VAC coils
- Meets UL508 and UL873
- 2.5kV dielectric

Competitor parts

- TE - T9A/T9C
- Omron - G8P
- Song Chuan - 895

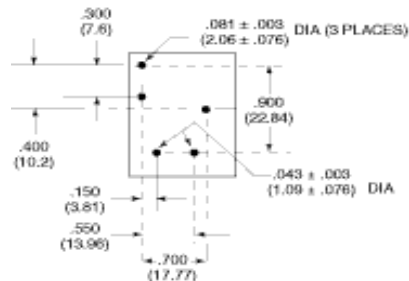
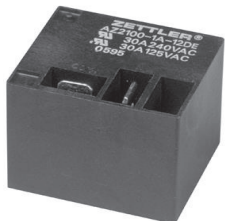

AZ2270 - Power Low Profile PCB w/QCT

- Contact rating of 30A; SPST, SPDT
- Class F insulation standard
- 5-120VDC; 12-277VAC coils
- Meets UL508 and UL873
- 4kV dielectric available

Competitor parts

- TE - T9A/T9C
- Omron - G8P
- Song Chuan - 832AWP

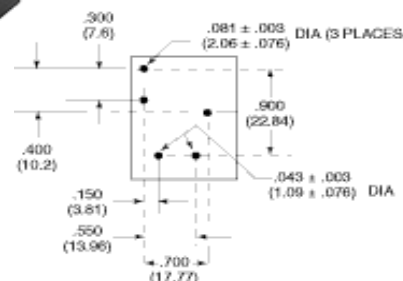

AZ2280 - Heavy Duty Panel Mount

- Contact rating of 30A; SPST, SPDT
- Class F insulation standard
- 5-120VDC, 12-277VAC coils
- Coil terminals available 0.1875" or 0.110"
- 2.5kV dielectric

Competitor parts

- TE - T9A/T9C
- Omron - G8P
- Song Chuan - 855AWP

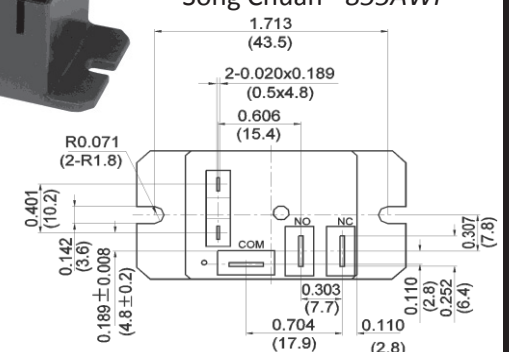
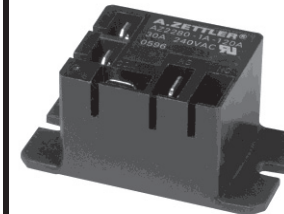

**AUTOMOTIVE AND
TRANSPORTATION RELAYS**

AMERICAN ZETTLER, INC.

It's a better relay!

Automotive and Transportation Relays

AZ9731 / AZ9741 (Mini-ISO)

- 40A - NO, 30A - NC switching
- SPST, SPDT, SPST-A2, 1 form U
- 6, 12, 24, 36, 48VDC coils
- Coil paralleled resistor or diode
- Multiple bracket types and mounting styles

Competitor equivalents

- TE - VF4 (V23134A, B, C, M)
- Panasonic - CB - Omron - G8JN
- Song Chuan - 896

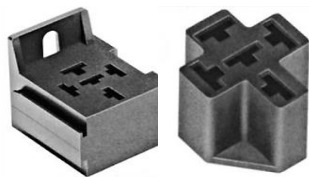

Socket: ST9721 series

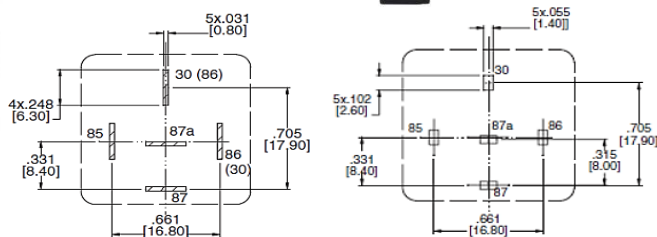

AZ979 / AZ980 / AZ983 (High Capacity Mini-ISO)

- 80A - NO, 60A - NC switching
- SPST, SPDT
- 6, 12, 24VDC coils
- Coil paralleled resistor or diode
- Multiple bracket types and mounting styles

Competitor equivalents

- TE - VF7 (V23134J)
- Panasonic - CB-H - Omron - G8JR
- Song Chuan - 897



Socket: ST980 series

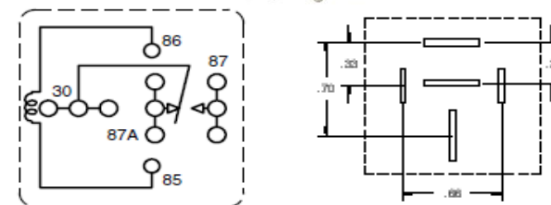

AZ977 (Micro-ISO)

- 35A - NO, 20A - NC switching
- SPST or SPDT
- 12 and 24VDC coils
- Coil paralleled resistor or diode
- Plug in or PCB type

Competitor equivalents

- TE - VFM (V23074)
- Panasonic - CM - Omron - G8HN
- Song Chuan - 871

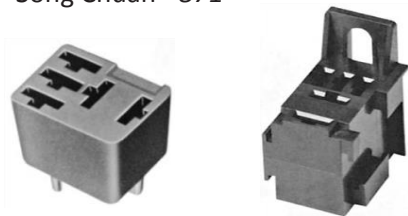

Socket: ST977 series

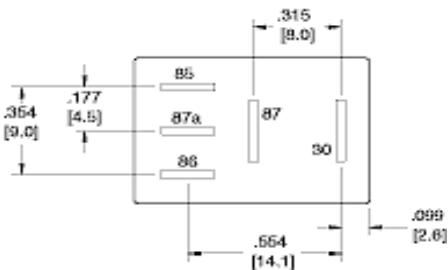

AZ986 / AZ9841 (ISO280 terminals)

- 40A - NO, 30A - NC (AZ986)
- 35A - NO at 35°C, 40A switching (AZ9841)
- SPST or SPDT
- 6, 12, 24VDC coils, sensitive version available
- Coil paralleled resistor or diode

Competitor equivalents

- TE - VF28/VJ28 - Omron - G8W/G8V
- Song Chuan - 898/301

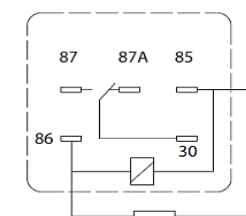
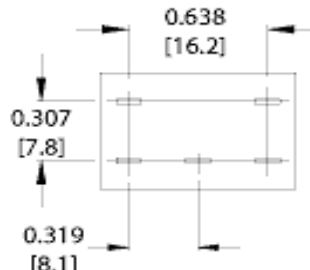
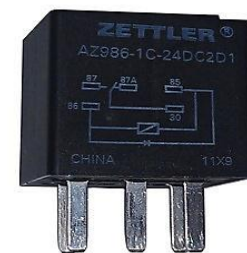

AMERICAN ZETTLER, INC.

It's a better relay!

Automotive and Transportation Relays

AZ9701 / AZ9711 (Power K)

- 45A - NO, 30A - NC
- SPST, SPDT
- 6, 9, 12, 24V
- US or Euro footprint
- Sealed or open

Competitor parts
 - TE - *VKP (V23076)*
 - Song Chuan - *822E*

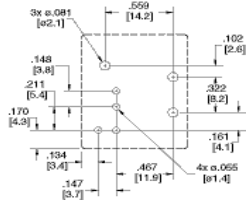

AZ9751 / AZ9761

- 20A or 2x10A
- 1 form A, B, C, U, V, W
- 6, 12, 24V
- Dust cover or open

Competitor parts
 - TE - *VKM (V23072)*
 - Song Chuan - *861*

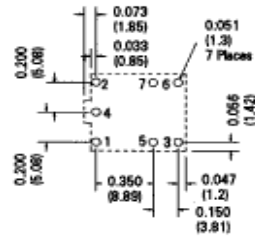

AZ9871 (Micro K)

- 30A / 25A switching
- SPST, SPDT, 2xSPST, 2xSPDT
- 10, 12, 24V
- Single or twin package

Competitor parts
 - TE - *V23086*
 - Panasonic - *PC1*
 - Omron - *G8PE*

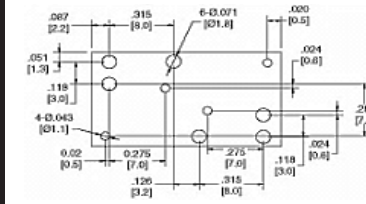

AZ934 / AZ935

- 25A/20A switching
- SPDT, 2xSPDT
- 12V
- Standard or quiet

Competitor parts
 - TE - *V23084*

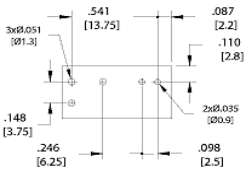
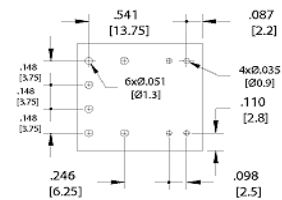

AZ9891J

- 30A switching
- 12V coil
- Standard or sensitive

Competitor parts
 - Omron - *G8N*
 - Song Chuan - *103*
 - Sanyou - *SARA*

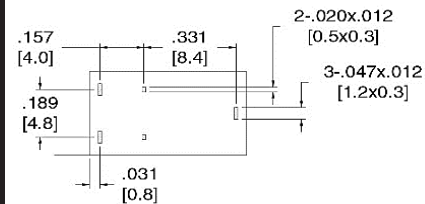

AZ9471

- 20A (60A surge)
- SPDT
- 6, 9, 10, 12, 18, 24V

Competitor parts
 - TE - *T72M*
 - Panasonic - *JJM/CQ*
 - Omron - *G8QN*
 - Song Chuan - *895*

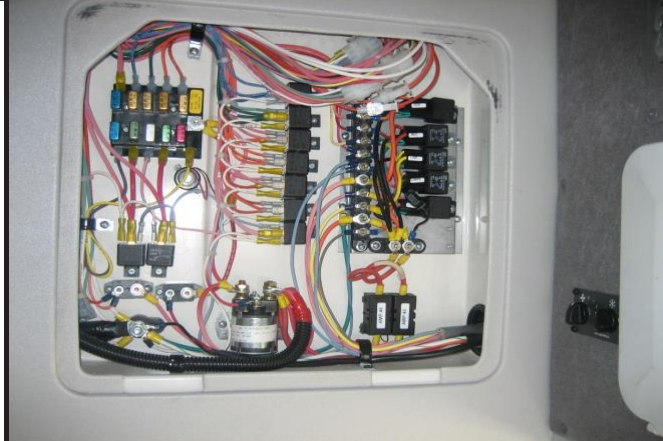
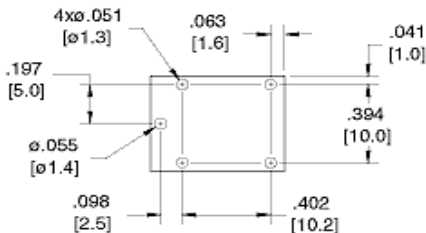

AZ9421A

- 20A
- SPST, SPDT
- 6, 12, 24V

Competitor parts
 - TE - *T72M*
 - Panasonic - *JSM*
 - Omron - *G8SN*
 - Song Chuan - *833HM/812HM*

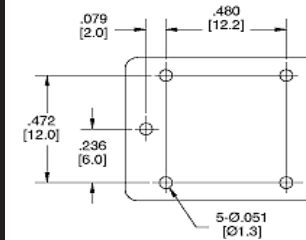

AMERICAN ZETTLER, INC.
It's a better relay!

Industrial / HVAC Relays

AZ1641 / AZ1651 / AZ1661 - Ice Cube Relay

- SPDT - 20A; DPDT/3PDT - 10A; 4PDT - 5A
- PCB, Plug-in, Plug in with mounting bracket
- 6-110VDC coils; 6-220V AC coils
- Din Rail and PCB sockets available

- Competitor parts**
- Idec - *RH/RV/RM*
 - Finder - *55 Series*
 - Panasonic - *HC/HJ/HL*
 - Omron - *LY/MY*
 - TE/Schrack - *KHA/ZT/TM*
 - Song Chuan - *SCL (A,B,D)*
 - Carlo Gavazzi - *RPY*

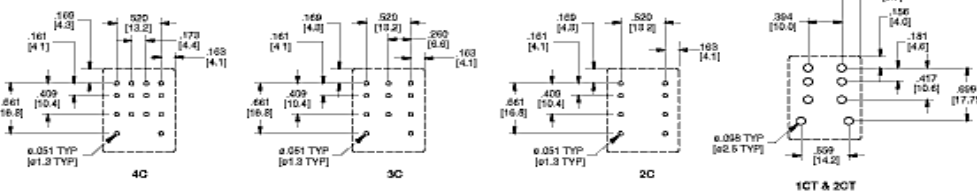

AZ6991 - Single Inline Package

- Contact rating of 6A
- Thin 5.0mm package, single inline pins
- "Flat" version (horizontal mounting)
- 3-60VDC coils
- 4kV dielectric, isolation spacing >8.0mm
- Din Rail socket available

- Competitor parts**
- Idec - *RV8H*
 - Finder - *34 Series*
 - Panasonic - *PE*
 - TE/Schrack - *V23092/SNR*
 - Song Chuan - *882*
 - Fujitsu - *FTR-LY*

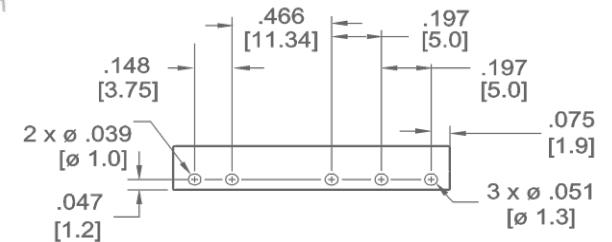

AZ420 - Cradle Relay

- Contact ratings to 5A; signal level switching
- 3-115VDC coils with sensitive versions available
- Current and voltage sensitive types
- DPDT, 4PDT, 6PDT contact configurations
- Life expectancy >100MM operations
- PCB or solder/plug-in terminals

- Competitor parts**
- TE - *V23154, R10*
 - Telemecanique - *T154, T163*

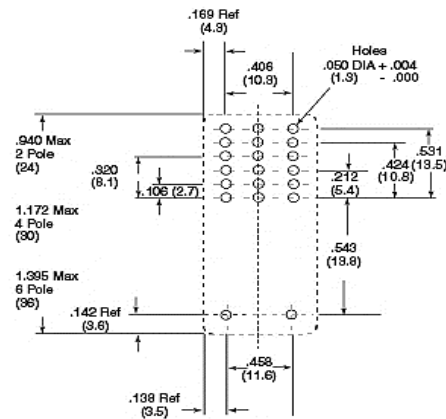

AZ576 / AZ742 / AZ743 - General Purpose Socketable

- SPST, SPDT 20A; DPST, DPDT - 10A
- 5-110VDC, 24-230VAC coils
- UL approvals for 100K cycles at 105°C
- Class F insulation available
- 5kV dielectric; 10mm isolation spacing
- Din Rail and PCB sockets available

- Competitor parts**
- Idec - *RQ*
 - Finder - *41 series*
 - Omron - *G2RL/G5RL*
 - TE - *RTD/RTE*
 - Song Chuan - *507/888H*

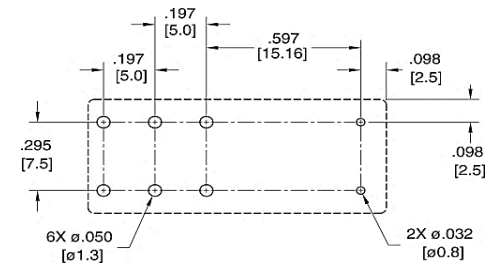
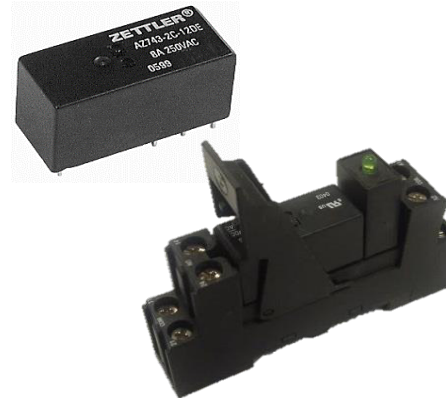

AMERICAN ZETTLER, INC.

It's a better relay!

Industrial / HVAC Relays

AZKUP - Plug-in Relay

- Contact rating of 13A; SPDT, DPDT, 3PDT
- Class F insulation standard
- 12-110VDC coils; 12-240VAC coils
- Standard cover or flange mounting

Competitor parts

- Finder - 62/65 Series
- Omron - MJN
- TE - KUP
- Magnecraft - A283
- Midtex - 157
- Song Chuan - 731/735

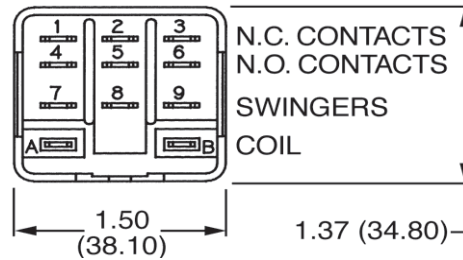

AZ2800 / AZ2850 - Compressor, UL1995 Electric Heater Relay

- Contact rating of 30A; DPST, DPDT
- 6-110VDC coils; 12-277VAC coils
- 4kV dielectric; meets 8.0mm creepage
- Ideal for UL1995 applications
- UL approvals to 100K cycles
- Panel mount or PCB
- Class F insulation standard

Competitor parts

- Finder - 66 Series
- TE - T92
- Carlo Gavazzi - CF
- Magnecraft - W92

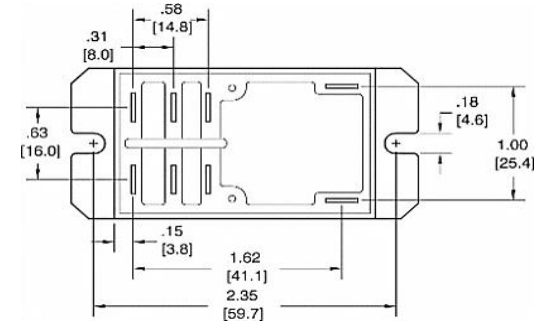

ZCPR - Motor Start Potential Relay

- Switching loads of 16A, 35A, and 50A@400VAC
- Class B insulation
- Coil voltages from 168VAC - 588VAC; eight different coil versions
- Six mounting positions including one non-position sensitive
- Mounting: metal tab; panel mount; plastic tab with panel mount

Competitor parts

- Electrica - RVA
- Hartland - HCR-4
- Products Unlimited - Type 38



AZPRD - High Capacity, Open-frame

- Contact rating 30-50A
- SPST, SPDT, DPST, DPDT
- Class F construction
- 6-110VDC coils; 6-480VAC coils
- Blow-out magnet and aux contacts
- Multiple output styles

Competitor parts

- TE - PRD
- Square D - 8501
- Magnecraft - MGN

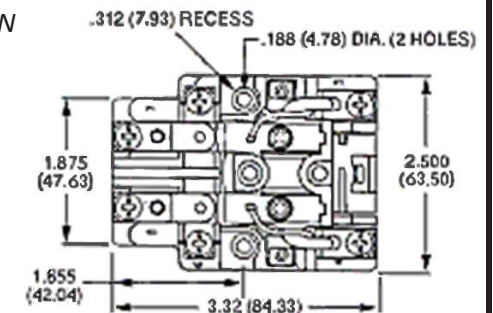
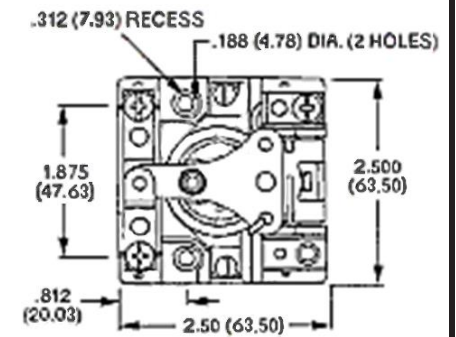
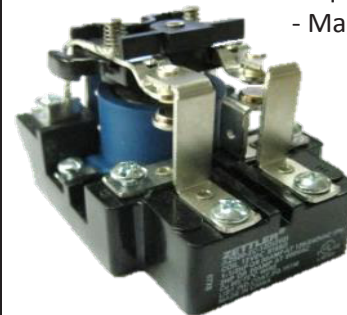

AMERICAN ZETTLER, INC.
It's a better relay!

Latching, Lighting, Metering Relays

AZ850 / AZ851- 3rd Generation Low Profile

- Contact rating of 1A, carry current 2A; DPDT
- Monostable, single, and dual latching coils
- 3-48VDC coils (24VDC max for latching)
- Meets FCC Part 68.302 - 1.5kV lightning surge
- THT or SMT

Competitor parts

- TE - V23106
- Panasonic - TQ2
- Omron - G6H
- NEC - EB2

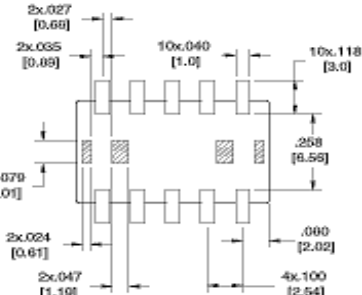

AZ8462 - 3rd Generation Slim Line

- Contact rating of 2A; DPDT
- Monostable, single, and dual latching coils
- 1.5-48VDC coils (24VDC max for latching)
- Meets FCC Part 68.302 - 1.5kV lightning surge
- Meets Bellcore 2.5kV surge
- THT or SMT

Competitor parts

- TE - V23079 / P2
- Panasonic - TX2
- Omron - G6S
- NEC - EC2/EE2

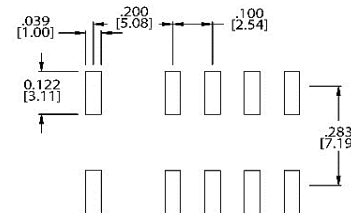

AZ832 - Polarized, Latching Option

- Contact rating of 2A; DPDT
- Monostable, single, and dual latching coils
- 3-48VDC coils with sensitive versions available
- Meets FCC Part 68.302 - 1.5kV lightning surge
- Meets FCC Part 68.304 - 1.0kV dielectric

Competitor parts

- TE - 23042
- Omron - G6A
- Panasonic - DS2Y/DS2E
- Hasco - HAS212

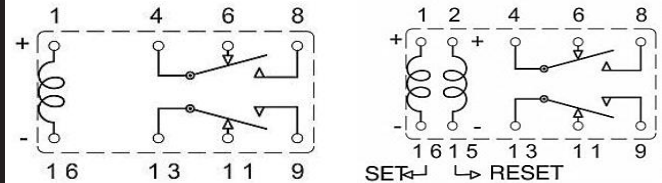

AZ852 / AZ8521 - 4th Generation Low Profile

- Contact rating of 2A; DPDT
- Monostable and single latching coils
- 1.5-24VDC coils
- Meets FCC Part 68.302 - 1.5kV lightning surge
- Meets Bellcore 2.5kV surge
- THT or SMT

Competitor parts

- Panasonic - AGQ
- TE - IM
- Omron - G6K
- NEC - UC2/UD2

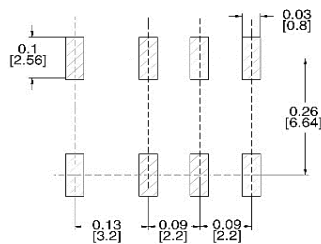

AZ880/888 - Low Profile Latching Relay

- Contact rating of 10A (SPST) and 8A (DPST)
- Narrow package available (8A-SPST, 5A-DPST)
- SPST, DPST (2 form A or 1 form A + 1 form B)
- Monostable, single, and dual latching coils
- 3-24VDC coils; Class F available
- 4kV dielectric

Competitor parts

- Omron - G6B/G6C
- Panasonic - DSP/DK/ADY
- KG Tech - K107/108

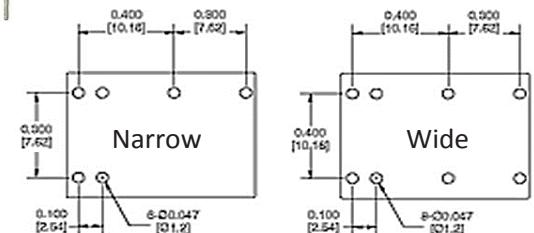

AMERICAN ZETTLER, INC.

It's a better relay!

Latching, Lighting, Metering Relays

AZ2500 / AZ2501 / AZ2501L - 347V Ballast

- Contact rating of 50A, 60A
- Single or dual latching coils w/override option
- UL ballast load approvals to 347VAC
- UL approvals to 100K cycles
- 5-48VDC coils
- 4kV dielectric



Competitor parts

- KG Tech - *K109/110*
- Picker - *PC910*

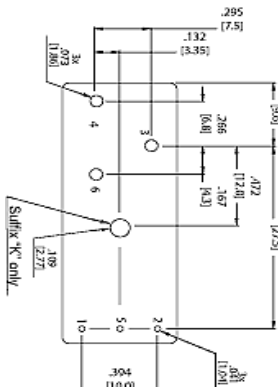

AZ2505 - Power Latching, Meets UC3

- Contact ratings of 60A, 80A, 100A, 120A
- Single latching coil; 5-24VDC
- Manganin shunt and sensing wires available
- Outputs: flying leads; copper bus bar; PCB
- Meets UC3 requirements
- 4kV dielectric



Competitor parts

- Wanjia - *WJ31A*
- KG Tech - *KG125A*

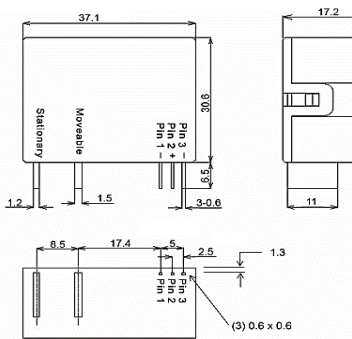

AZPRD - Motor and Lighting Control

- Contact rating 30-50A; SPST, SPDT, DPST, DPDT
- Class F construction
- 6-110VDC coils; 6-480VAC coils
- Blow-out magnet and aux contact available
- Multiple output styles

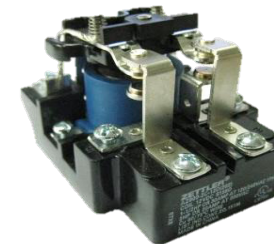

Competitor parts

- TE - *PRD*
- Square D - *8501*
- Magnecraft - *MGN*

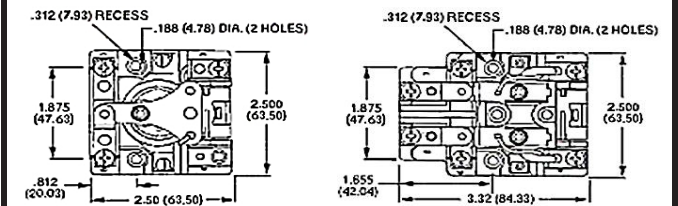

AZ762P - All-Purpose Medium Duty Latching

- Contact rating of 20A; SPST, SPDT
- SPST option with Tungsten + AgSnO contact
- Single and dual latching coils; 3-24VDC
- UL ratings to 100K cycles
- 4.4kV dielectric



Competitor parts

- TE - *RT1*
- Omron - *G2RK*
- KG Tech - *K106*

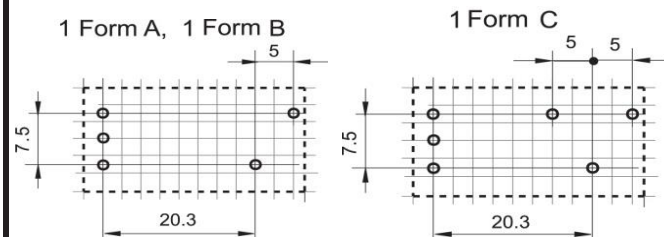

AZ21501P - Energy Management to 50A

- Contact ratings of 30A, 40A, 50A@277VAC
- Single latching coil; 5-48VDC
- Manual override option
- Meets UL20 requirements



Competitor parts

- CIT - *LF115F1*
- Hasco - *HAT901-L*

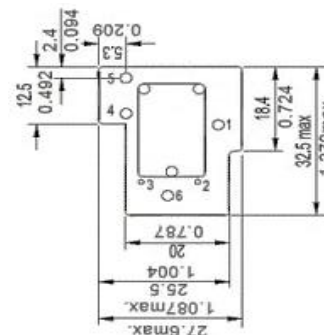

AZ932 - Photocontrol Relay

- Contact rating of 15A; SPST-NO or NC, SPDT
- Class F insulation available; 3-48VDC coils
- UL approvals for 100K cycles
- TV5 / ballast rated; passes ANSI C136.10
- High inrush design



Competitor parts

- TE - *T7C/ORWH/PCE*
- Panasonic - *JS1*
- Omron - *G5LA/G5LE*
- Song Chuan - *899/307*

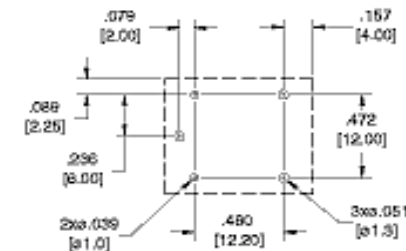

POWER RELAYS

AMERICAN ZETTLER, INC.

It's a better relay!

Power Relays

AZ9321 - High Inrush, Ballast Rated

- Contact rating of 25A; SPST-NO or NC, SPDT
- Class F insulation available
- 3-48VDC coils
- UL approvals for 100Kcycles
- High inrush design
- TV5 / ballast rated; Photo control applications



Competitor parts

- TE - T7C/ORWH/PCE
- Panasonic - JS1
- Omron - G5LA/G5LE
- Song Chuan - 899/307

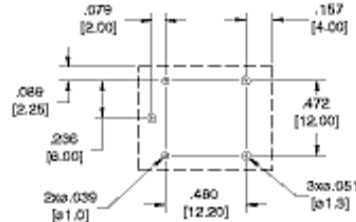

AZ7335 - Double Pole, All-Purpose

- Contact rating of 8A; DPDT
- Class F insulation available
- 3-48VDC coils
- 5kV dielectric; 10kV surge



Competitor parts

- Song Chuan - 793
- Omron - G2R-2
- TE - RP, RKA/RKS, OMI
- Panasonic - JW2
- Fujitsu - FBR620

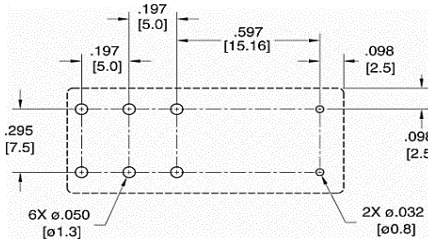

AZ7555 - High Capacity, All-Purpose

- Contact rating of 20A; SPST, SPDT
- 3-48VDC coils with sensitive version (120mW)
- UL approvals for 100K cycles at 85°C
- 5kV dielectric; 10kV surge
- Din Rail and PCB sockets available



Competitor parts

- TE - OZ, OMIH
- Omron - G2R
- Panasonic - JW/JR1AF
- Song Chuan - 793

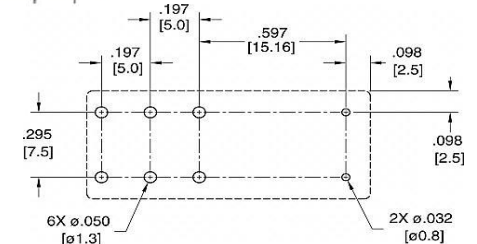

AZ2100 - Power PCB w/QCT

- Contact rating of 40A; SPST, SPDT
- Class F insulation available
- 5-110VDC, 12-240VAC coils
- Meets UL 508 and UL873
- 2.5kV dielectric



Competitor parts

- TE - T9A/T9C
- Omron - G8P
- Song Chuan - 895

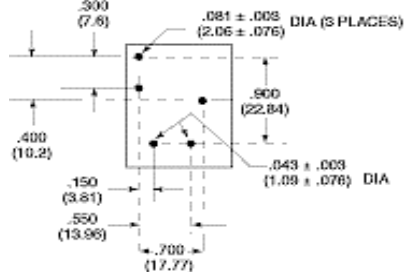

AZ2150 - Heavy Duty PCB

- Contact rating of 40A; SPST, SPDT
- Class F insulation available
- 5-110VDC, 12-240VAC coils
- Meets UL508 and UL873
- 4kV dielectric available



Competitor parts

- TE - T90/T9A
- Omron - G8PT
- Song Chuan - 832A
- Sanyou - SLA

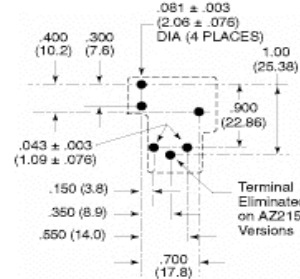

AZ2280 - Heavy Duty Panel Mount

- Contact rating of 30A; SPST, SPDT
- Class F insulation standard
- 5-110VDC, 12-277VAC coils
- Coil terminals available 0.1875" or 0.110"
- 2.5kV dielectric

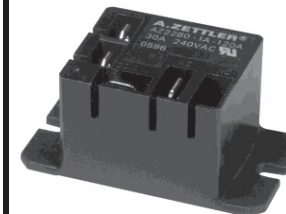

Competitor parts

- TE - T9A/T9C
- Omron - G8P
- Song Chuan - 855AWP

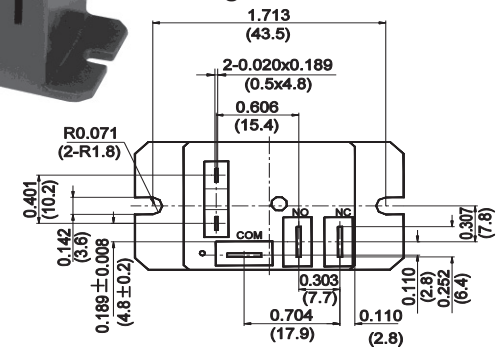

AMERICAN ZETTLER, INC.

It's a better relay!

Power Relays

AZ2700-AZ2705

- 30A contact; 1 form X, 2 form X (SPST, DPST dual contact)
- Class B insulation standard; Class F available
- 3-200VDC; 6-240VAC coils
- Standard contact gap - 2.4mm; 3.0mm option
- 4kV dielectric available

Competitor parts

- Omron - *G7L*
- Panasonic - *HE*
- Magnecraft - *725*
- Song Chuan - *510*

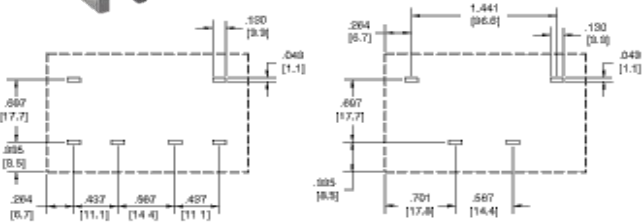

AZ2505

- Contact ratings of 60A, 80A, 100A, 120A
- Single latching coil; 5-24VDC
- Manganin shunt and sensing wires available
- Outputs: flying leads, copper bus bar, PCB
- Meets UC3 requirements
- 4kV dielectric

Competitor parts

- Wanjia - *WJ31A*
- KG Tech - *KG125A*

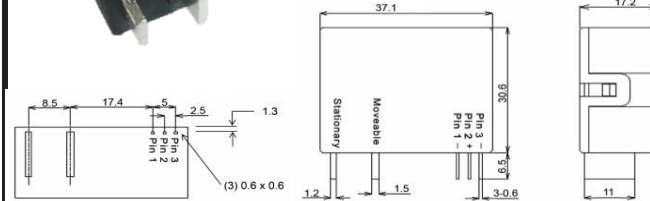

AZPRD

- Contact rating 30-50A; SPST, SPDT, DPST, DPDT
- Class F construction
- 6-110VDC coils; 6-480VAC coils
- Blow-out magnet and aux contact available
- Multiple output styles

Competitor parts

- TE - *PRD*
- Square D - *8501*
- Magnecraft - *MGN*

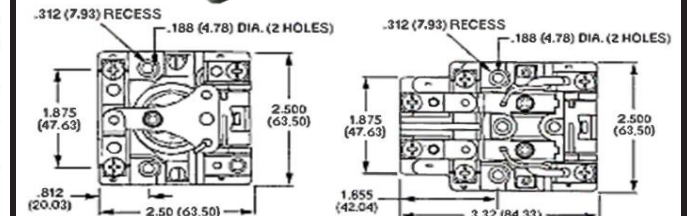
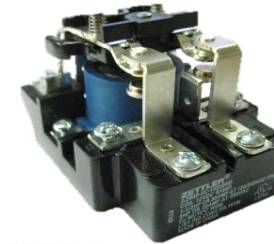

AZ2800 / AZ2850 - Compressor, UL1995

- Contact rating of 30A; DPST, DPDT
- 6-110VDC coils; 12-277VAC coils (Class F std)
- UL approvals to 100K cycles
- 4kV dielectric; meets 8.0mm creepage
- Panel mount or PCB

Competitor parts

- Finder - *66 Series*
- TE - *T92*
- Carlo Gavazzi - *CF*
- Magnecraft - *W92*

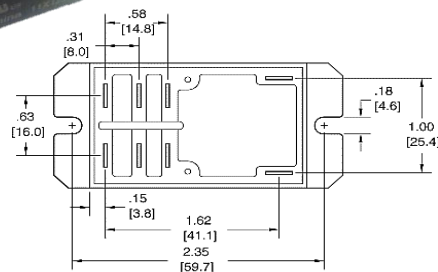

AZDC - High Voltage DC Switching

- 10 to 300A; 1 form X (SPST, double-make)
- 750kW max switch power (300A)
- 2500A max switch current (@300VDC)
- 1000VDC max switch voltage
- 12-24VDC coils
- Hermetically sealed

Competitor parts

- TE - *EV*
- Omron - *G9E*
- Panasonic - *EP300A*

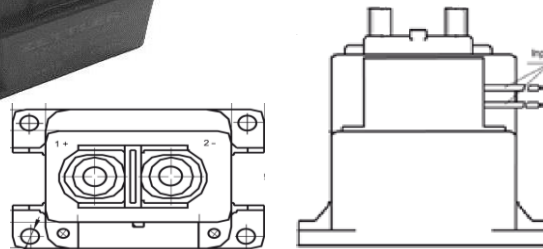

XMCO - Definite Purpose Contactor

- 25-90FLA; 1-4 pole, 1 pole w/shunt
- UL rated 250K cycles; SCCR 100kA@600VAC
- Class F insulation
- 12-600VAC coils (50Hz or 60Hz)
- Meets ARI 780/790

Competitor parts

- TE - *3100*
- Hartland - *HCC*
- Furnas - *42/45*
- Square D - *8910*
- Cutler - *C25*

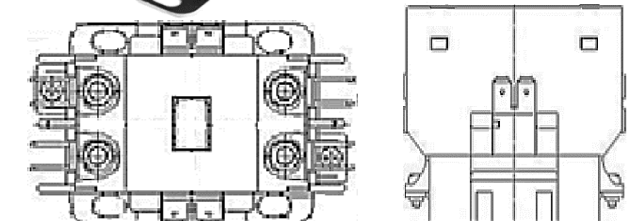
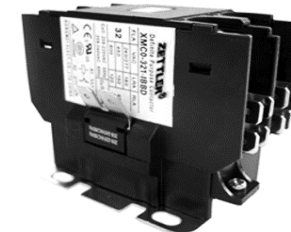

SOLAR / EVSE RELAYS

AMERICAN ZETTLER, INC.

It's a better relay!

Solar / EVSE Relays

AZ733W - Wide Gap Double Pole

- Contact rating of 10A; DPST-NO, DPDT
- Class B insulation available
- 3-60VDC coils
- Contact gap options of 1.5mm or 2.0mm
- 5kV dielectric
- PCB and Din Rail socketable



Competitor parts
 - Fujitsu - *FTR-F4G*
 - Song Chuan - *894*

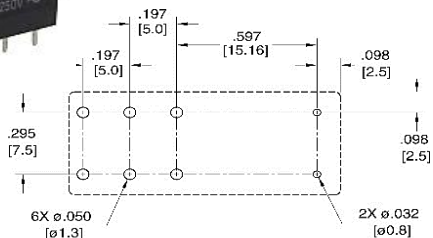

AZ576 / AZ761 / AZ762

- SPST, SPDT 20A; DPST, DPDT - 10A
- 5-110VDC; 24-230VAC coils
- UL approvals for 100K cycles at 105°C
- 5kV dielectric; 10mm isolation spacing
- Din Rail and PCB sockets available



Competitor parts
 - Idec - *RQ*
 - Finder - *41 series*
 - Omron - *G2RL/G5RL*
 - TE - *RTD/RTE*
 - Song Chuan - *507/888H*

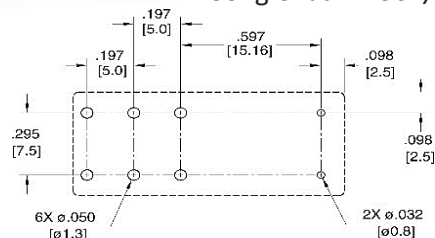

AZ2150W - Wide Gap 30A Relay

- Contact rating of 30A; SPST
- Class F insulation standard
- 5-48VDC coils
- Contact gap of 1.75mm
- 3kV dielectric available



Competitor parts
 - Omron - *G8P*
 - Panasonic - *JT-G*

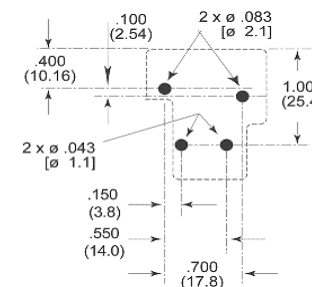

AZSR126 - Solar Inverter Relay

- Contact rating of 26A; SPST-NO
- Max. switching current of 31A
- 9-24VDC coils
- Contact gap of 1.5mm
- 4.5kV dielectric



Competitor parts
 - TE - *PCFN*
 - Fujitsu - *FTR-K3WG*
 - Panasonic - *LF-G*
 - Song Chuan - *110*

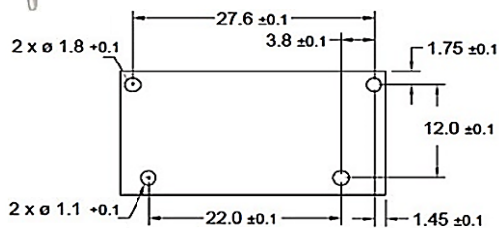

AZSR235 / AZSR250 - Solar Inverter Relay

- Contact rating of 35 or 50A; SPST, DPST
- 5-24VDC coils
- Contact gap of 1.75mm
- Reinforced insulation
- 5kV dielectric
- Holding power of <100mW

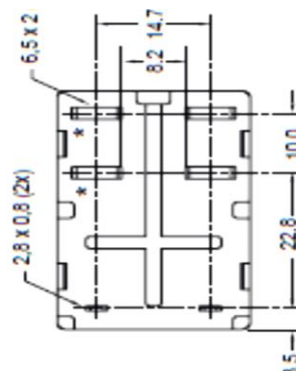

AZ2800 / AZ2850 - Level 1 / Level 2 charging

- Contact rating of 30A; DPST, DPDT
- 6-110VDC coils; 12-277VAC coils (Class F std)
- UL approvals to 100K cycles
- 4kV dielectric; meets 8.0mm creepage
- Panel mount or PCB



Competitor parts
 - Finder - *66 Series*
 - TE - *T92*
 - Carlo Gavazzi - *CF*
 - Magnecraft - *W92*

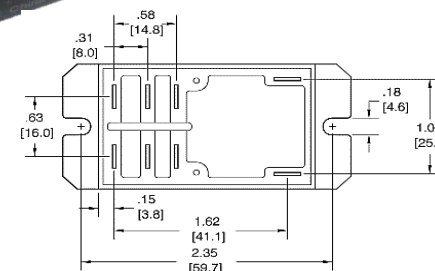

AMERICAN ZETTLER, INC.

It's a better relay!

Solar / EVSE Relays

AZ2700-2705

- 30A contact; 1 form X, 2 form X (SPST, DPST dual contact)
- Class B insulation standard; Class F available
- 3-200VDC; 6-240VAC coils
- Standard contact gap of 2.4mm; 3.0mm option
- 4kV dielectric available



Competitor parts

- Omron - G7L-PV
- Panasonic - HE
- Magnecraft - 725
- Song Chuan - 510

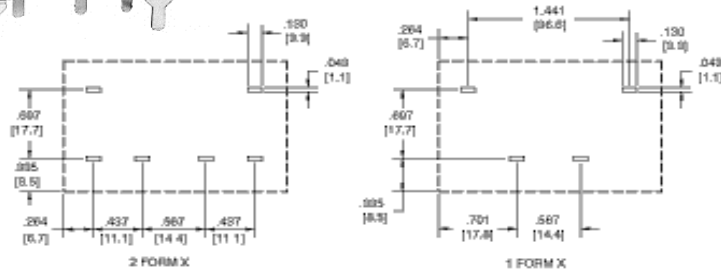

AZPRD

- Contact rating 30-50A; SPST, SPDT, DPST, DPDT
- Class F construction
- 6-110VDC coils; 6-480VAC coils
- Blow-out magnet and aux contact available
- Multiple output styles

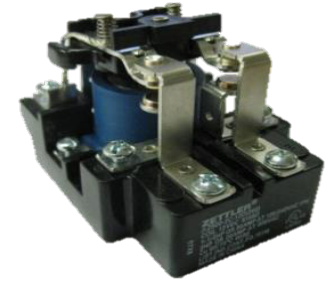

Competitor parts

- TE - PRD
- Square D - 8501
- Magnecraft - MGN

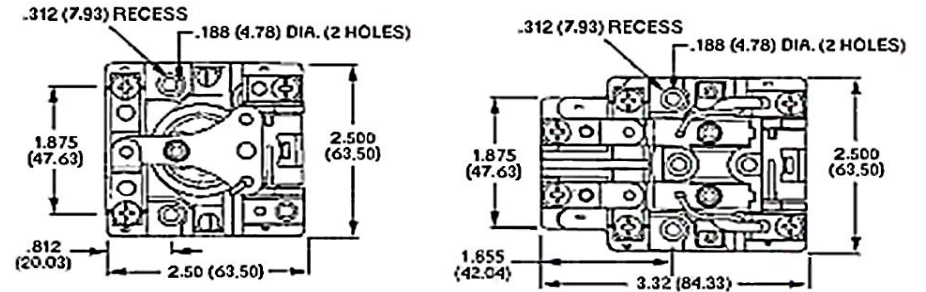

XMCO - Definite Purpose Contactor

- 25-90FLA; 1-4 pole, 1 pole w/shunt
- Class F insulation
- 12-600VAC coils (50Hz or 60Hz)
- UL rated 250K cycles; SCCR 100kA@600VAC
- Meets ARI 780/790

Competitor parts

- TE - 3100
- Hartland - HCC
- Furnas - 42/45
- Square D - 8910

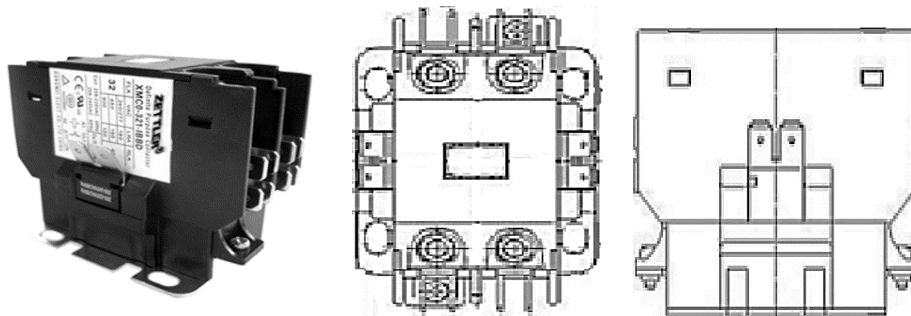

AZDC - High Voltage DC Switching

- 10 to 300A; 1 form X (SPST, double-make)
- 750kW max switch power (300A)
- 2500A max switch current (@300VDC)
- 1000VDC max switch voltage
- 12-24VDC coils
- Hermetically sealed

Competitor parts

- TE - EV
- Omron - G9E
- Panasonic - EP300A

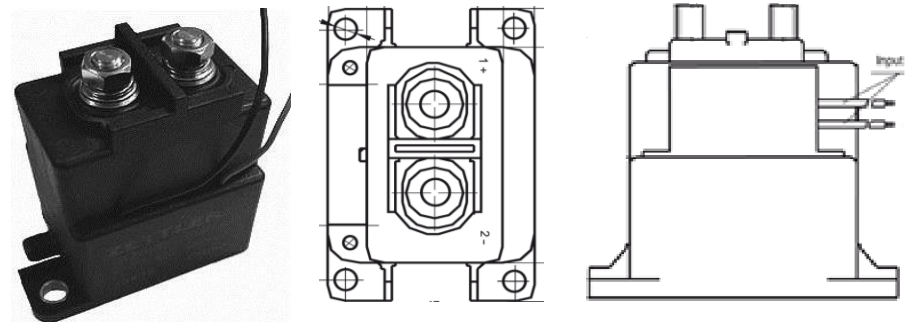

TRANSFORMERS

ZETTLER Magnetics, Inc. The Power to Transform!

Transformers

AH/ADH (Horizontal Split Bobbin)

- UL 5085 Class 1; Class B insulation
- Single (AH) or dual (ADH) primaries
- 115/230V@50/60Hz
- Series or parallel output
- 2500Vrms dielectric
- VA ratings: 1.1; 2.4; 6; 12; 20

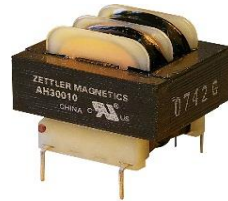

Applications

- Small appliances; controls
- Meters
- Smoke detectors

Competitor parts

- Signal - *ST / DST*
- MCI - *4-01 / 4-02*
- Pulse - *ST*
- Premier - *PSB*

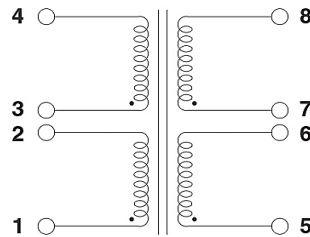
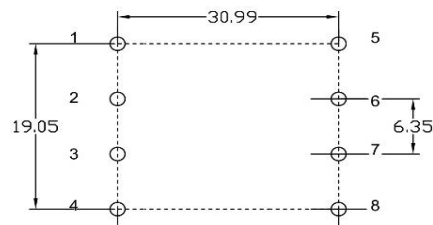

AHI (Standard PCB Power Transformer)

- UL 5085 Class 2, 3
- Class B insulation system
- Constructed to meet VDE
- 115/230V@50/60Hz
- Dual, non-concentric bobbins
- 4200Vrms dielectric
- VA ratings: 2.5; 5; 10

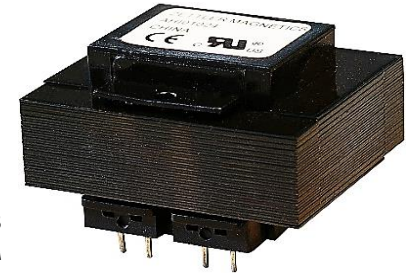

Applications

- Spa controls
- Food service equipment
- Appliance controls

Competitor parts

- Signal - *CL2 and 14A*
- MCI - *4-44*
- Tamura - *PL*
- Premier - *DVD*

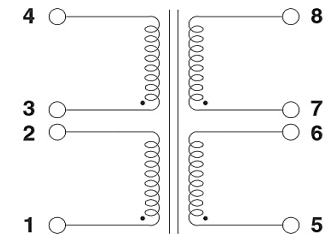
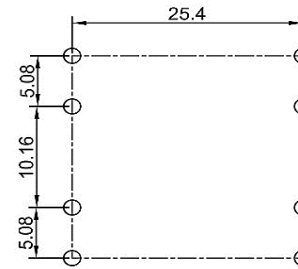

AHF (Low Profile Power Transformer)

- UL 5085 Class 1
- 115/230V@50/60Hz
- Series or parallel output
- 1500Vrms dielectric
- VA ratings: 2.4; 6; 12



Applications

- Water treatment
- Video / security equipment
- Solar energy
- Surge suppressors

Competitor parts

- Signal - *LP*
- MCI - *4-05*
- Tamura - *3FL*
- Premier - *SPW*

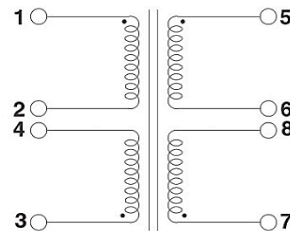
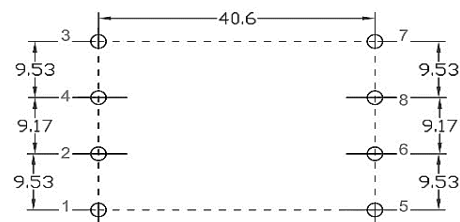

ACST (Current Sense Transformer)

- Class B insulation system
- 1 to 30A sensing range to 200Hz
- Typical output of 110mV per Ampere
- 3000Vrms dielectric



Applications

- Power meters
- Temperature controls
- Lighting controls
- Motor controls

Competitor parts

- Triad - *CST*

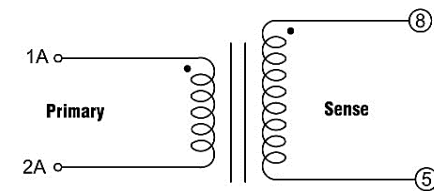
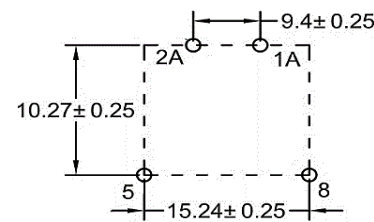

AHR / AHRV (Chassis Mounted Transformer)

- UL 5085 Class 2
- Class B insulation system
- Input range from 120-575VAC
- Multiple mounting, wiring, and termination options
- VA ratings: 20 - 100

Applications

- HVAC
- Lighting
- Food equipment
- Motors and pumps
- Irrigation systems
- Tankless water heater

Competitor parts

- TE - 4000
- Hartland - HCT



Flying leads



Bell housing

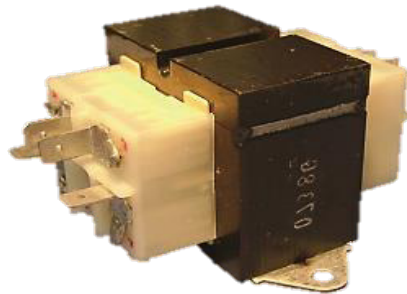

Quick connect terminals



External fuse or circuit breaker

Toroidal Transformers

- Class B insulation system
- Single or dual primaries
- Primary voltages from 100-240VAC (50 or 60Hz)
- Multi-tap secondaries
- Secondary voltages from 12-80VAC (50 or 60Hz)
- 3000Vrms dielectric
- VA ratings: 80 to 600

Applications

- Lighting
- Massage chairs
- Pumps
- Audio equipment
- Welders



Chokes and inductors



Inductors



Drum core chokes

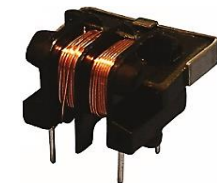

Common mode chokes

Custom requirements welcome!



Tombstone CTs

Transformers

ZETTLER Magnetics, Inc.
The Power to Transform!

BP and ZP (Encapsulated Switch Mode Power Modules)

ZP series 3W
single output

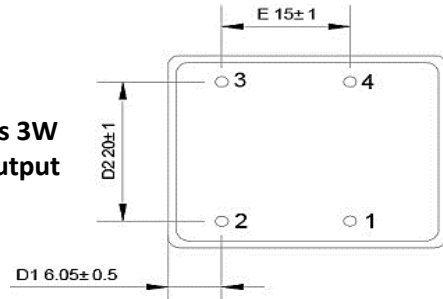

ZP series 10W
dual output

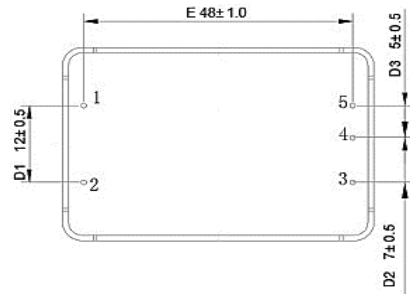

BP series

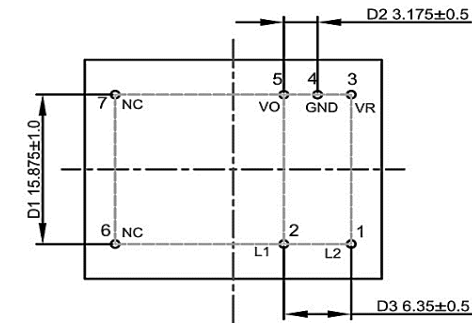

Competitively Priced “Plug and Play” Solution for Your PCB Power Requirements



Zettler’s BP & ZP series miniature AC-DC encapsulated power modules provide a competitively priced “plug and play” solution for your PCB power requirements.

- Wireless applications
 - Lighting/energy management controls
 - Building automation controls
-
- Power outputs: 1W, 3W, 5W, & 10W
 - Input voltage ranges from 90-480VAC, 50/60Hz
 - Regulated 3.3V-24VDC, single and dual output options
 - Output over-voltage, over-power, and short circuit protection
 - Dielectric strength of 3600VAC
 - Integrated EMC network
 - Low ripple and noise
 - UL, TUV, CE on most parts
 - Customizable parameters

ZETTLER Magnetics, Inc.
The Power to Transform!

BV (Encapsulated Power Transformer)

- UL 5085 Class 1
- UL 5085 Class 2; VDE
- Vacuum sealed
- Single / dual secondaries
- 4200Vrms dielectric
- VA ratings: 0.35 - 60

Competitor parts

- Pulse - BV
- Spitznagel - SPK
- Signal - IF
- Thai Lin - TL30

Applications

- Small motors
- White goods
- Power meters
- Solar inverters
- Food service equipment

Smaller and less expensive than equivalent VA open-frame type

High surge resistance



Touch safe

Excellent thermal properties

Power Ferrite Switching Transformers

- Wide input voltages from 85 - 265VAC
- Power ranges from 1.5 - 180W
- Primary / secondary insulation $\geq 4kV$
- Primary / auxiliary insulation $\geq 1.5kV$
- Creepage distance primary / secondary $\geq 6mm$
- Construction conforms with IEC950, IEC335, IEC61558
- Uses UL94v0 listed materials

Applications

- High frequency power supplies
- Ballasts
- TVs/monitors

Highly customizable

Rapid prototyping

Automated insulation insertion



E16



EE19

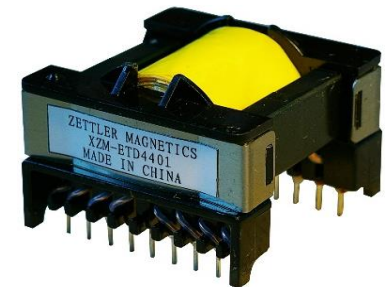

ETD44



EF20

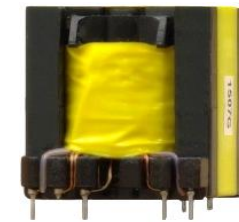

ERL28